

Zawias puszkowy kątowy 90°, ze sprężyną dociągającą KT

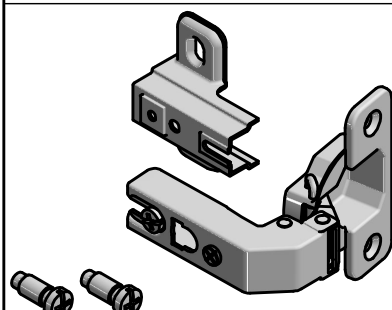

Informacje handlowe

Zawias kątowy krótkie ramię



Opcja	Prowadnik	Numer katalogowy
Z Euro	H6	ZP-KTK90H6ZE-BZAS-ZB

Planowanie

Zawias kątowy - krótkie ramię

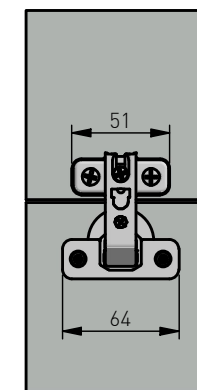
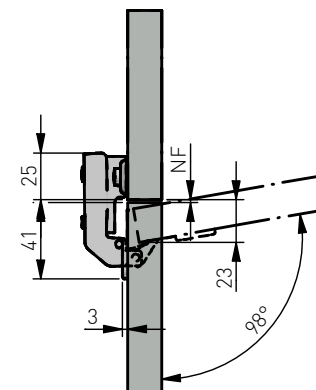

Montaż

Montaż prowadnika w korpusie

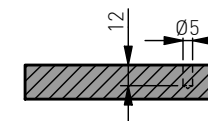

Montaż na wkręty EURO

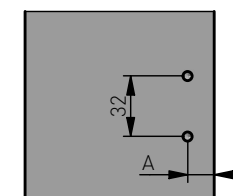

A- odległości prowadnika od krawędzi
Wpuszczane
A=14

Montaż puszkii we froncie

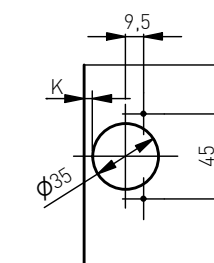
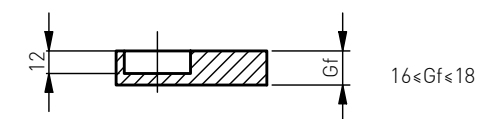

Natożenie frontów dla różnych odległości K

Odległość puszkii od krawędzi K	
Natożenie frontu = NF	
-4	-3
-2	-1
0	0
H=6	3 4 5

Regulacja

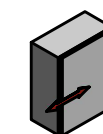

±2mm

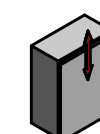

±2mm

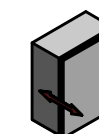

- 0,3 +2 mm